

USER GUIDE

For Pico Neo 3 Pro Series

In The Box

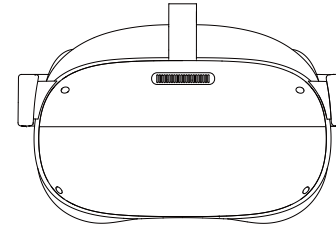

VR Headset

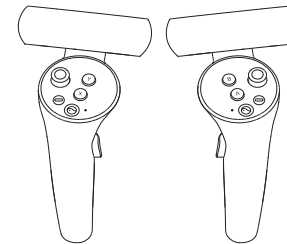

Controller



User Guide

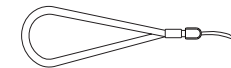

Controller Lanyard

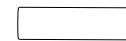

1.5V AA Battery



USB-C 2.0 Data Cable

* The product package list is subject to change due to different regions. These instructions are for reference only.

Important Health & Safety Notes

- This product is designed and intended to be used in an open and safe indoor area, free of any tripping or slipping hazards. To avoid accidents, remain conscious of the potential confines of your physical area and respect the boundary of your virtual area. Be sure to wear the lanyard when using the Controllers. Make sure that there is enough space around your head (at least 2 meters by 2 meters). You will need enough space to stretch your arms in order to avoid damage or injury to yourself, others, on your surroundings.
- This product is not recommended for users under 12 years of age. 12 years and older should only use this product under adult supervision.
- This product is designed to accommodate most prescription glasses. Take care to wear the VR Headset in a manner in which the VR Headset lenses do not rub or impact your prescription lenses.
- Prolonged use may cause dizziness or eye fatigue. It is recommended that you take a break every 30 minutes. You may be able to relieve by focusing on distant objects. If you feel any discomfort, please stop using the product immediately.
- Do not expose the optical lenses to direct sunlight or other strong light sources. Exposure to direct sunlight may cause permanent yellow spot damage on the screen. Screen damage caused by sunlight exposure or other strong sources of light is not covered by the warranty.
- To reduce the risk of discomfort, the inter-pupillary distance (IPD) should be appropriately set for each user. (The function is supported in Pico Neo 3 Pro only. Pico Neo 3 Pro Eye is not supported.)
- This product has an "Eye Protection Mode" certified by TUV Rheinland (Germany), which can protect your eyes by reducing blue light in the channels using software algorithms. The screen appears yellowish in this mode and you can turn this feature on/off in "Settings" -> "Display" -> "Eye Protection Mode."
- Protect optical lenses during use and storage to prevent damage.

* Product and packaging are updated regularly, and the functions and contents of the standalone headset may be upgraded in the future. Therefore, the content, appearance and functionality listed in this manual and product packaging are subject to change and may not reflect the final product. These instructions are for reference only.

6 Degrees of Freedom VR

The device can track your translational and rotational movements in all directions up/down, left/right, forward/backward, pitch, roll, and yaw. Your movements in the real world will be captured and translated to what you see in the virtual world when using the appropriate content.

Ensure a safe environment before you start your VR experience.

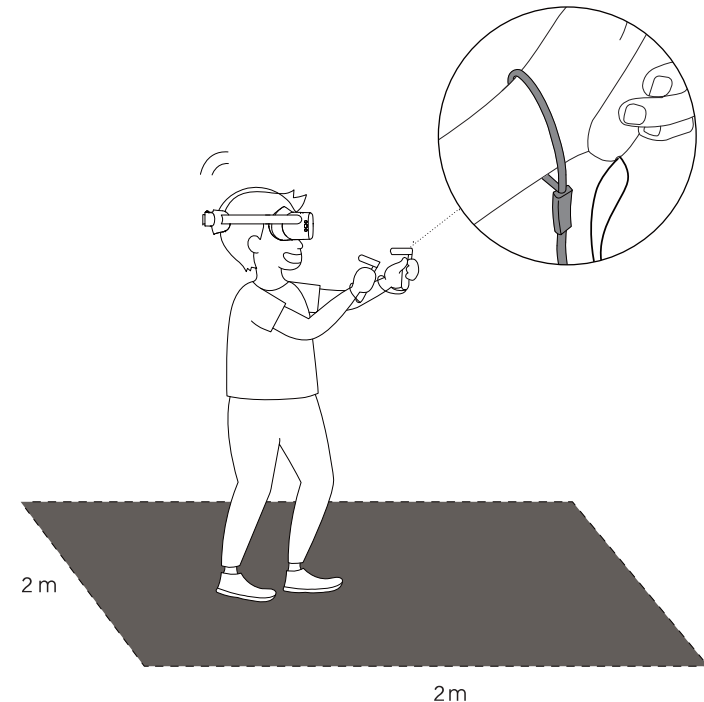

1. Clear a safe indoor area of at least 2 meters by 2 meters. Keep the room brightly lit. Do not use a space with large single color walls, glass, mirrors and moving pictures or objects.
2. Remove the protective film that covers the headset front cameras. Wear the lanyard connected to the Controllers.
3. Set up your environment by following instructions on the VR Headset screen.

Note: This product cannot guarantee your safety. You must always pay attention to the surrounding safety.

Quick Guide

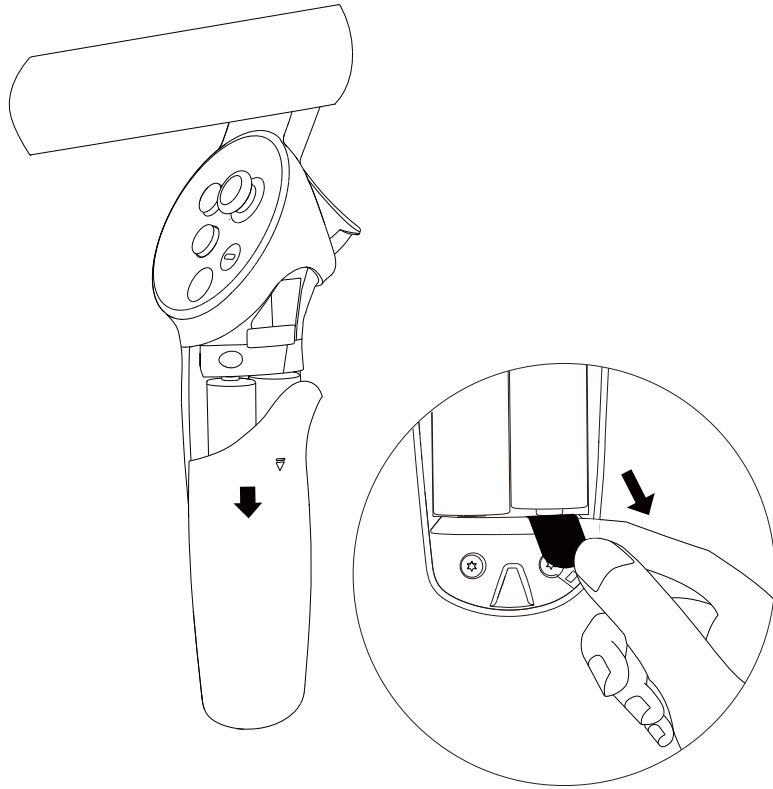

1

Installing Batteries

Press the area marked with an arrow and slide the cover down, then pull the tab to remove the insulating paper.

***Note: The 1.5V AA batteries are recommended.**



2

Power on the Controller

Short press the HOME button until the status indicator flashes blue.

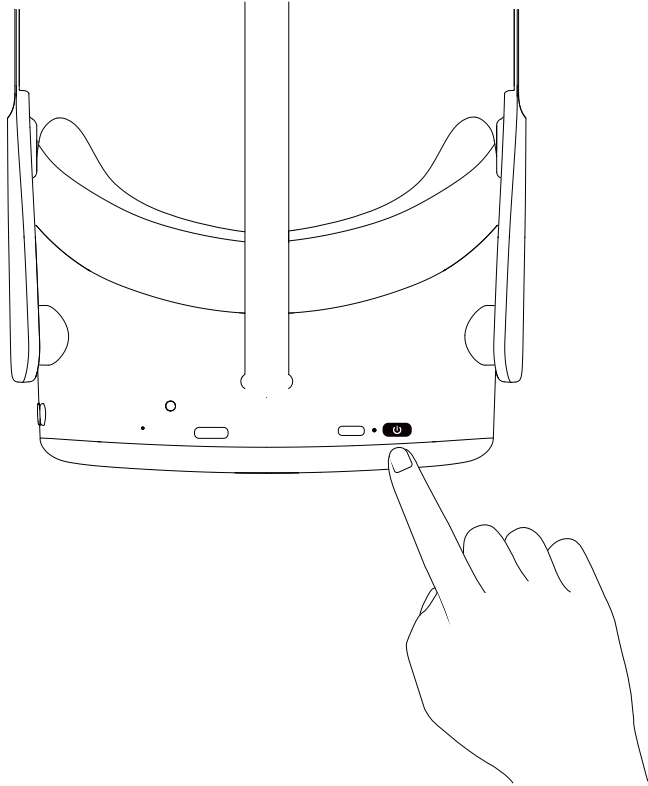

3

Power on the VR Headset

Long press the POWER button for two seconds until the status indicator turns blue.

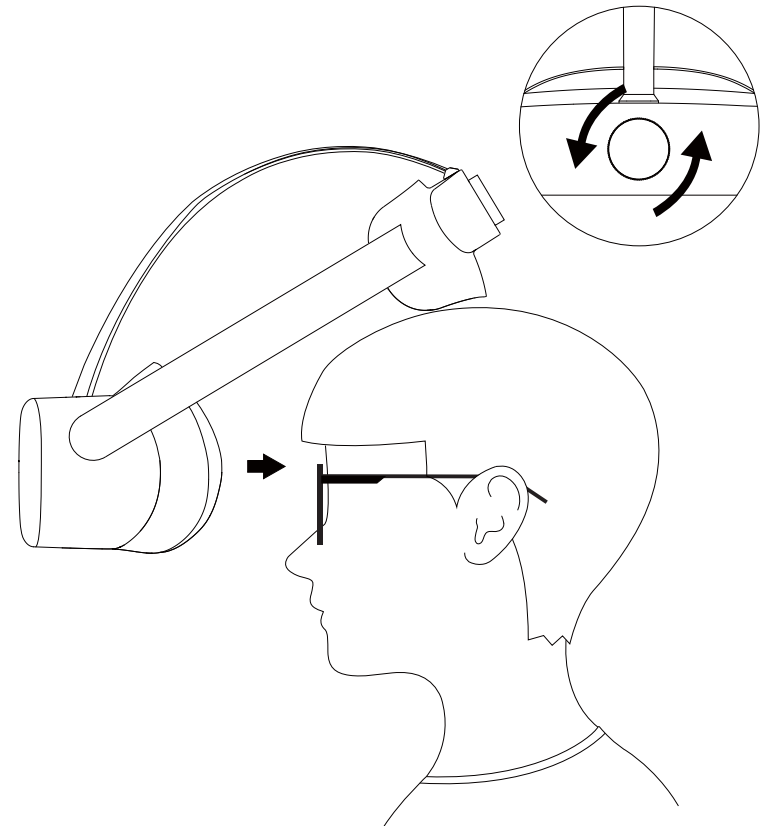

4

Wear the VR Headset

Turn the strap dial counter clockwise to loosen the VR Headset. Rotate the strap up to ensure the enough space for head.

Note: Nearsighted users can use this product with prescription glasses.

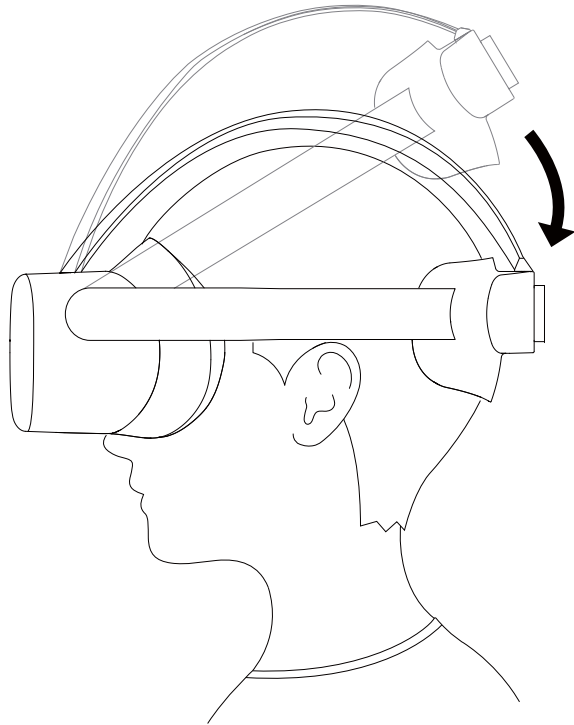

5

Adjust the Wearing Position

Rotate the strap down over your head. Turn the strap dial clockwise to tighten the VR Headset in a comfortable position.

Pico Neo 3 Pro VR Headset Details

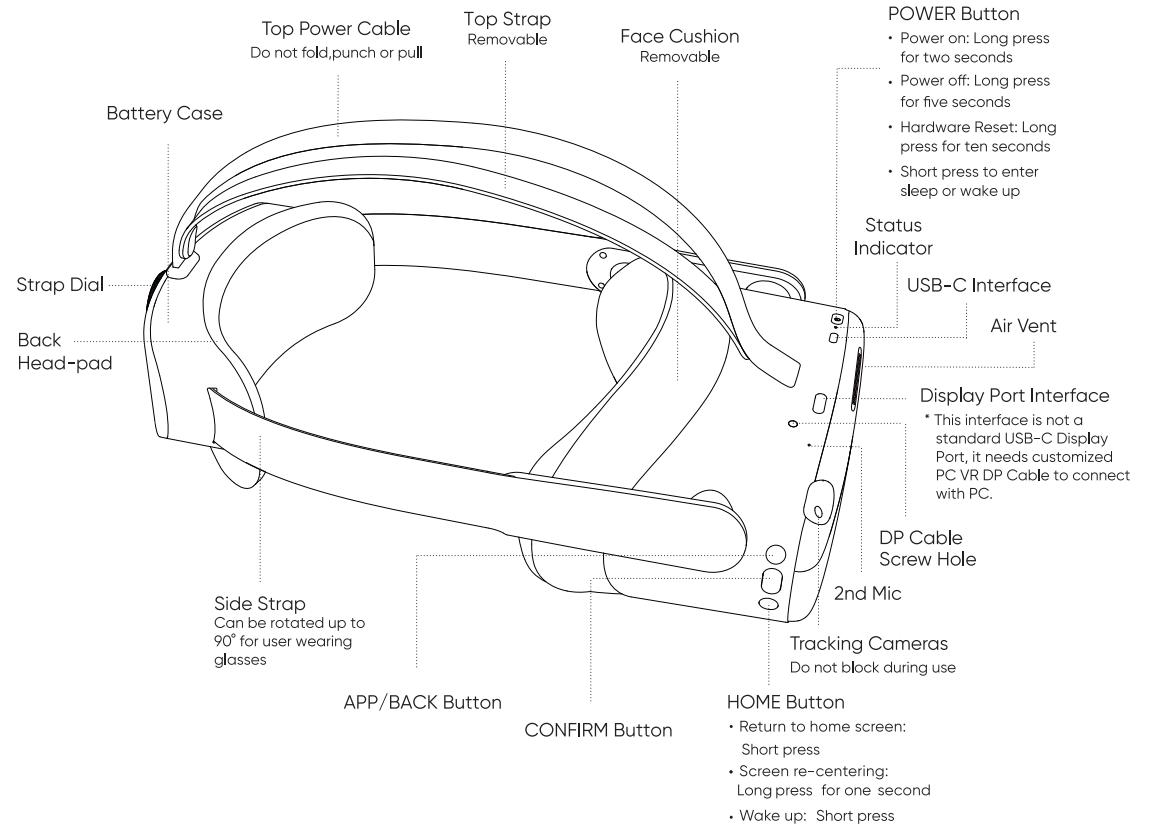

VR Headset Status Indicator Legend

- Blue: Powered on with battery over 20%
- Yellow: Charging Battery is less than 98%
- Red: Charging Battery is less than 20%
- Red flashing: Battery is less than 20%
- Blue flashing: Shutting down
- Green: Charging complete
- Off: Sleeping or Powered off

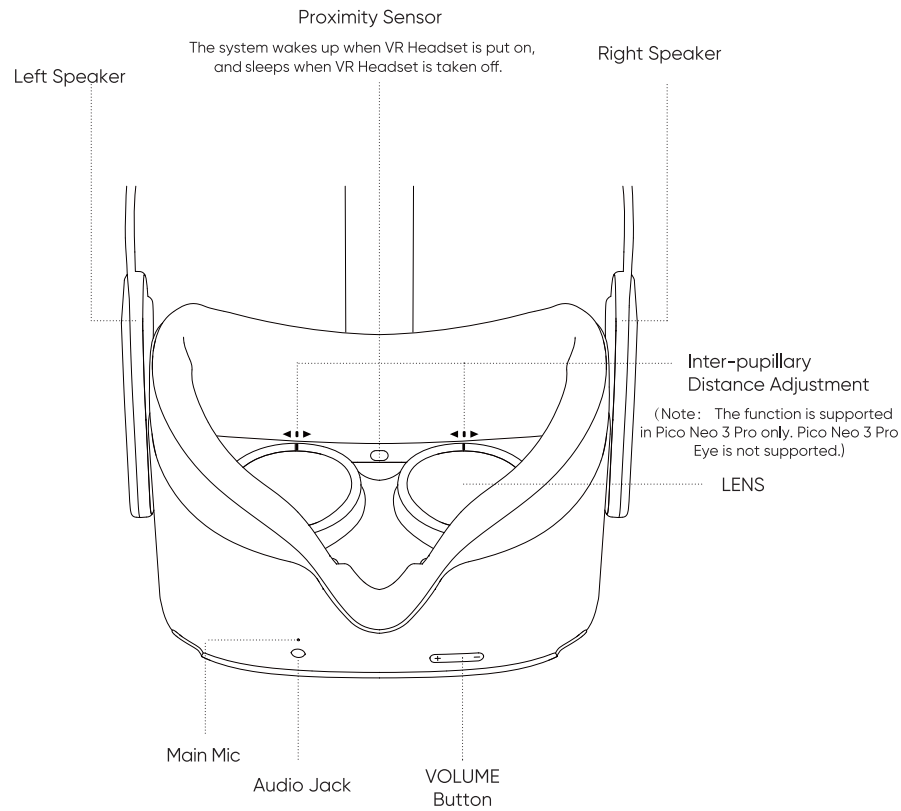

- **Head Control Mode**

If the Controller is not connected, you can interact with the home screen by moving your head to direct the crosshairs over your intended selection and clicking the HOME, CONFIRM, and BACK buttons on the VR Headset.

- **Screen re-centering**

If you find the images have drifted off-center, look straight ahead, press and hold the HOME button of the Controller for more than second to re-center the screen.

- **Audio volume adjustment**

You can use the VOLUME button of the VR Headset to turn up or turn down the volume. Press it to continuously adjust the volume.

- **VR Headset reset**

If the picture in the VR Headset is stuck, or the VR Headset does not respond after short-pressing the HOME or POWER buttons, reboot the VR Headset by pre-ssing the POWER button on the VR Headset for more than ten seconds.

- **Sleep/Wake up**

- **Option 1 Proximity Sensor:**

Take off VR Headset for automatic sleeping; wear the VR Headset for automatic waking up.

- **Option 2 POWER Button:**

Press the POWER button for manual sleeping or waking up.

- **IPD Adjustment**

To ensure image clarity, it is necessary to line up the lenses with the distance between your pupils (IPD).

There are three lens spacing settings—58mm, 63.5mm, and 69mm. To adjust the IPD, gently move both lenses inward or outward to find the clearest setting.

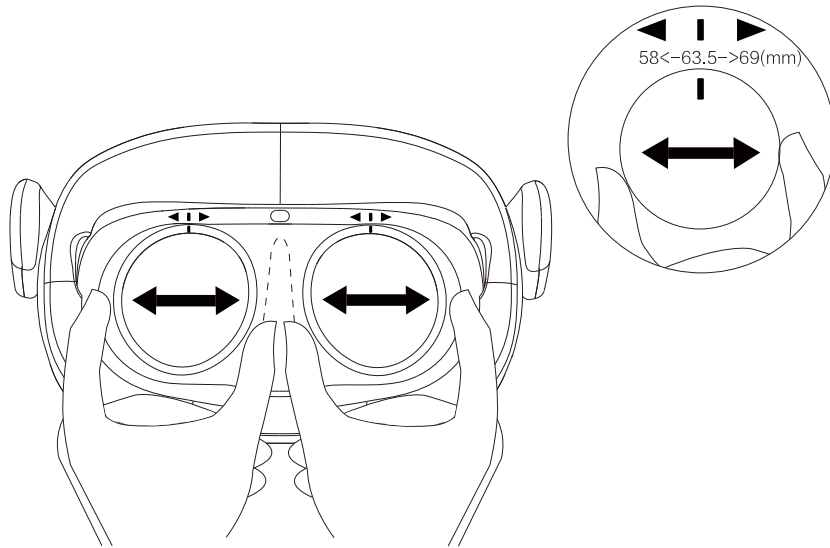

Note: The function is supported in Pico Neo 3 Pro only. Pico Neo 3 Pro Eye is not supported.

- **The VR Headset adjustment**

This device has no myopia adjustment function. The VR Headset allows wearing most standard glasses with a frame width of less than 160mm.

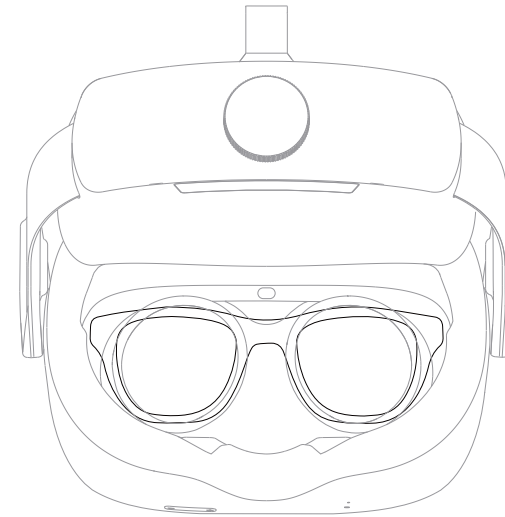

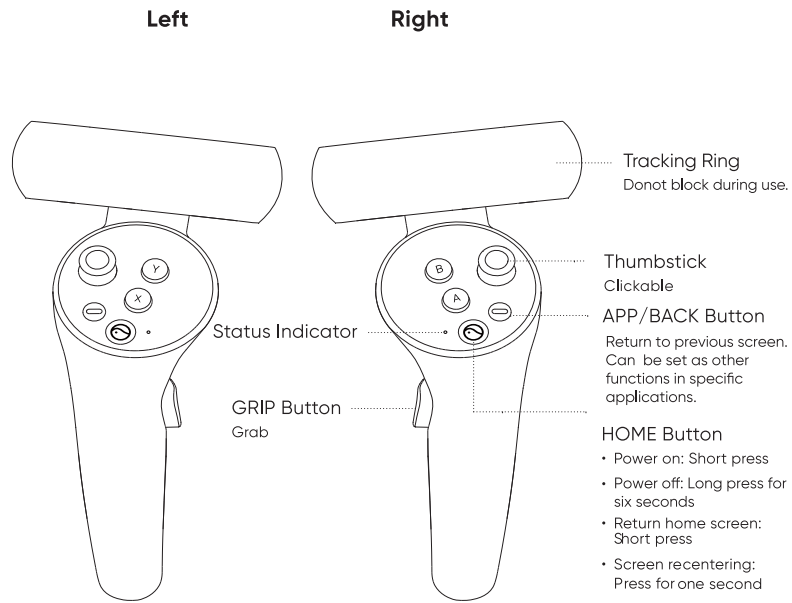

Controller Status Indicator Legend

- Blue: Connected to VR Headset 🔦 Blue flashing: Searching for connection
 - Red and blue flashing alternately: ● Off: Powered off
- Pairing in progress

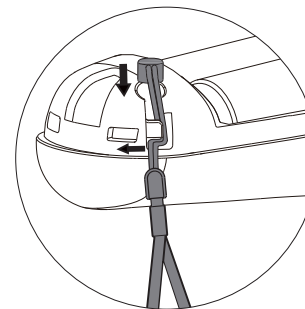
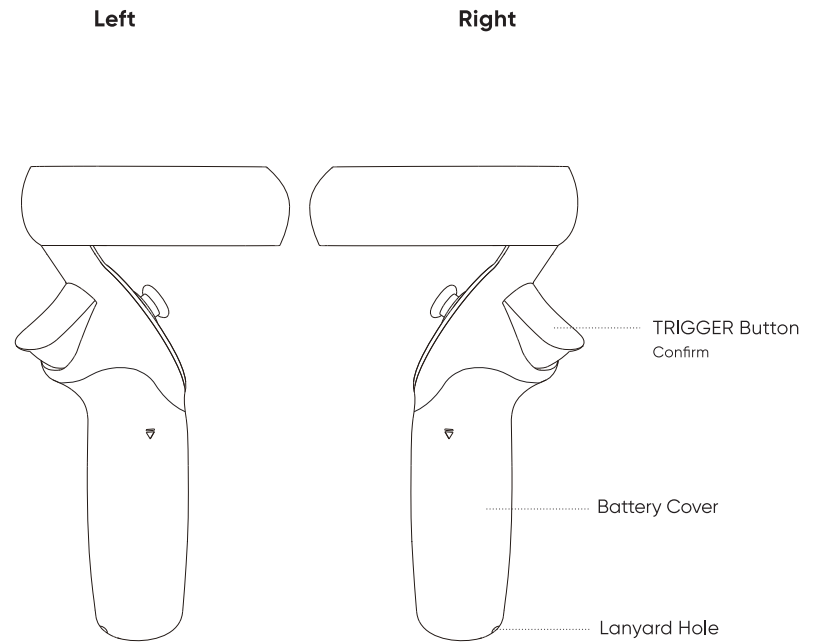

* Note: Install the Controller Lanyard by following the above picture.

- **Thumbstick operation**

Four directions are available for page-turning; Pressing down is available.

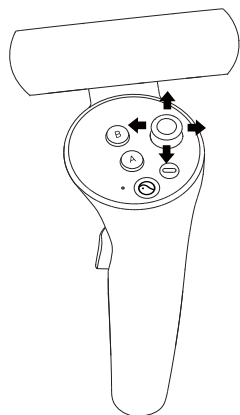

- **Browsing contents**

Moving and rotating the Controller/VR Headset to navigate, and select the content with the TRIGGER button of the Controller or the CONFIRM button of the VR Headset.

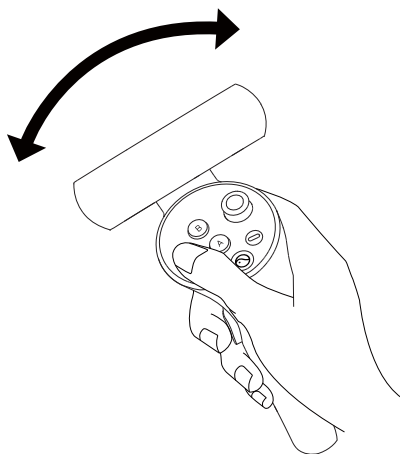

• **Note:** If the Controller is not connected, you can browse content by turning your head and clicking the buttons on the VR Headset.

- **Switch the pointer of the master Controller**

In the home screen, short press the TRIGGER button of the corresponding Controller to switch the pointer of the master Controller.

- **Screen re-centering**

Wear the VR Headset, look straight ahead, then press and hold the HOME button of the Controller for more than one second to re-center the screen.

- **Disconnect the Controller**

Press and hold the HOME button until the status indicator turns red and the Controller vibrates. The Controller will power off and pairing will reset automatically.

Controllers will automatically shut down to save power in the following cases:

- When the VR Headset enters deep sleep (a few moments after the VR Headset is taken off)
- When the Controller is unbound in the Controller Management Interface of the VR Headset
- When the VR Headset is powered off

- **Add new Controller**

If you need to add a new Controller or re-connect with an unbundled Controller, go to "Settings" -> "Controller", and click on "add Controller." Press and hold the HOME and TRIGGER buttons of the Controller at the same time until the red and blue lights of the Controller flash alternately, and then follow the instructions on the VR Headset screen. NOTE: The VR Headset can only connect one left Controller and one right Controller.

- **Hardware reset**

If the virtual Controller in the VR Headset is stuck, or the HOME button and buttons of the Controller do not respond, you can remove the batteries and insert again to restart the Controller.

Product Care

This VR headset features a replaceable face cushion and straps. The face cushion and straps are available to purchase separately. Please contact customer service at service@picovr.com, a Pico authorized service provider, or your sales representative.

Lens care

- During use or storage, do not let hard objects touch the lens to prevent surface scratches.
- Use an optical lens microfiber cloth dipped in a little water or a non-alcoholic disinfectant wipe to clean the lenses. Do not wipe the lenses with alcohol or other harsh or abrasive cleaning solutions, as this may lead to damage.

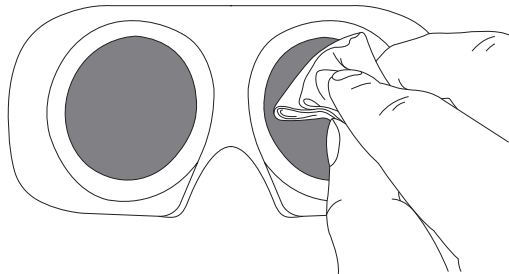

Face cushion care

Use sterile wipes (alcohol-based ingredients allowed) or a microfiber dry cloth dipped in a small amount of 75% alcohol solution to gently wipe the surface and surrounding areas that are in contact with the skin. Apply until the surface is slightly wet, and hold for at least five minutes. Dry before use. Do not expose directly to sunlight.

Note: The face cushion will have exhibit the following effects after repeated cleaning and disinfection. Hand washing or machine washing is not recommended, as this will accelerate these effects. Please replace the face cushion if any of the following occur:.

- Leather (PU) face cushion: color change, sticky surface hair, or decreased facial comfort on the face;
- Fabric face cushion: color change, surface fluff, soft texture, and increased possibility for the eyewear to come in contact with the lenses.

Headset and accessories care

Use disinfectant wipes (alcohol-based ingredients allowed) or a microfiber dry cloth dipped in a small amount of 75% alcohol solution to gently wipe the surface of the product. Apply until the surface is wet, wait at least 5 minutes, then dry with a microfiber dry cloth. Note: This does not apply to the lens and face cushion of the headset.

- Please avoid getting water into the product when cleaning.

Replacing face cushion

Insert the pin face cushion into the crevices along the edges, as shown below:

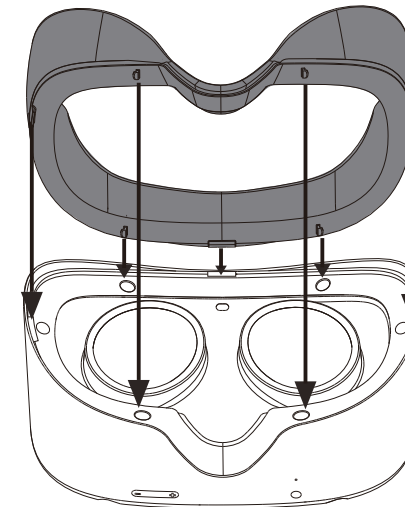

Regulatory

After powering on the headset, you can go to "Settings"-->"General"-->"About"-->"Regulatory" on the home page to view the certified supervision product information specific to your region.

Safety Warnings

Please read the following warnings and information carefully before using the VR Headset and follow all guidelines on safety and operation. Failure to follow these guidelines may result in physical injuries (including electric shock, fire, and other injuries), property damage, and even death. If you allow others to use this product, you shall be responsible for ensuring that every user understands and follows all safety and operational instructions.

Health and safety warnings

- Ensure that this product is used in a safe environment. By using this product to view an immersive virtual reality environment, users will not be able to see their physical environment. Move only within the safe area that you set: keep your surroundings in mind. Do not use near stairs, windows, heat sources, or other hazardous areas.
- Confirm that you are in good health before using. Consult a doctor before use if you are pregnant, elderly, or have serious physical, mental, visual, or heart problems.
- A small number of people may experience epilepsy, fainting, severe dizziness, and other symptoms caused by flashes and images, even if they have no such medical history. Consult a doctor before using if you have a similar medical history or have ever experienced any of the symptoms listed above.
- Some people may experience severe dizziness, vomiting, palpitations and even fainting when using VR Headsets, playing ordinary video games, and watching 3D movies. Consult a doctor if you have experienced any of the symptoms listed above.
- This product is not recommended for use by children under 12 years of age. Please keep your VR Headset, Controllers, and accessories out of reach. Children over 12 years old should use this product under adult supervision.
- Some people may be allergic to plastic, PU, fabric, and other materials used in this product. Long-term contact with skin may result in symptoms such as redness, swelling, and inflammation. Stop using the product and consult a doctor if you experience any of the symptoms listed above.
- This product is not meant for extended use over 30 minutes at a time with rest periods of at least 10 minutes between uses. Adjust resting and usage periods if you experience any discomfort.

- If you have a big difference in binocular vision, or a high degree of myopia, or astigmatism or far-sightedness, it is suggested that you wear glasses to correct your eyesight when using VR headset.
- Stop using the product immediately if you experience visual abnormalities (diplopia and sight distortion, eye discomfort or pain, etc.), excessive sweating, nausea, vertigo, palpitations, disorientation, loss of balance, etc. or other signs of distress.
- This product provides access to immersive virtual reality experiences some types of content may cause discomfort. Stop use immediately and seek medical treatment if the following symptoms occur.
 - Epilepsy seizures, loss of consciousness, convulsions, involuntary movements, dizziness, disorientation, nausea, somnolence, or fatigue.
 - Eye pain or discomfort, eye fatigue, eye twitching, or visual abnormalities (such as illusion, blurred vision, or diplopia).
 - Itchy skin, eczema, swelling, irritation or other discomforts.
 - Excessive sweating, loss of balance, impaired hand-eye coordination, or other similar motion sickness symptoms.

Do not operate a motor vehicle, operate machinery, or engage in activities that may have potentially serious consequences until you have fully recovered from these symptoms.

Impact on medical devices

- Please comply with the expressly stated prohibition of the use of wireless equipment in medical and healthcare facilities, and shut down the equipment and its accessories.
- Radio waves generated by this product and its accessories may affect the normal operation of implantable medical devices or personal medical devices, such as pacemakers, cochlear implants, hearing aids, etc. Please consult the medical device manufacturer about the restrictions on the use of this product if you use these medical devices.
- Keep a distance of at least 15cm from the implanted medical devices (such as pacemakers, cochlear implants, etc.) when this product and any accessories are connected. Stop using the headset and/or its accessories if you observe a persistent interference with your medical device.

Operating environment

- Do not use the equipment in dusty, humid, dirty environments, or near strong magnetic fields, in order to internal circuit failure of this product.
- Do not use this equipment during thunderstorms. Thunderstorms may cause product failure and increases the risk of electric shock.
- Protect your lenses from light. Keep the product away from direct sunlight or ultraviolet rays, such as windowsills, automobile dashboards, or other strong light sources.
- Keep the product and its accessories away from rain or moisture.
- Do not place the product near heat sources or exposed flames, such as electric heaters, microwave ovens, water heaters, stoves, candles or other places that may generate high temperatures.
- Do not apply excessive pressure to the product during storage or when in use to avoid damage to the equipment and lenses.
- Do not use strong chemicals, cleaning agents, or detergents to clean the product or its accessories, which may cause material changes that affect eye and skin health. Please follow the instructions in "ProductCare" to manage the health of the equipment.
- Do not allow children or pets to bite or swallow the product or its accessories.

Children's health

- CHOKING HAZARD: This product and its accessories may contain small parts. Please place these parts out of the reach of children. Children may inadvertently damage the product and its accessories, or swallow small parts resulting in are connected. Stop using the headset and/or its accessories if you observe persistent interference with your medical device, suffocation or other injury.

Requirements for accessories

- Only accessories approved by the product manufacturer, such as power supplies and data cables, can be used with the product.
- The use of unapproved third-party accessories may cause fire, explosion or other damages.
- The use of unapproved third-party accessories may violate the warranty terms of the product and the relevant regulations of the country where the product is located. For approved accessories, please contact Pico Customer Service

Center.

Environmental protection

- Dispose of your headset and/or accessories properly. Do not dispose of the headset or accessories in a fire or incinerator, as the battery may explode when overheated. Dispose separately from household waste.
- Please comply with the local laws and regulations on the disposal of electrical and electronic equipment to dispose of this product and its accessories.

Hearing protection

- Do not use high volume for extended periods of time to prevent possible hearing damage.
- When using headphones, use the minimum volume required to avoid hearing damage. Prolonged exposure to high volume may cause permanent hearing damage.

Flammable and explosive areas

- Do not use the equipment near fuel stations or hazardous areas containing flammable articles and chemical agents. Follow all graphic or text instructions when in possession of the product around these areas. Operating the product in these hazardous sites poses risk of explosion or fire.
- Do not store or transport the product or its accessories in the same container as flammable liquids, gases, or substances.

Transportation safety

- Do not use the product when walking, cycling, driving, or situations that require full visibility.
- Take caution if using the product as a passenger in a motor vehicle, as irregular movement may increase the risk of motion sickness.

Charger safety

- Only charging devices provided in the product package or specified as an approved device by the manufacturer should be used.
- When charging is completed, disconnect the charger from the equipment and unplug the charger from the power outlet.

- If the charging adapter or cable is damaged, discontinue using to prevent the risk of electric shock or fire.
- Do not operate the equipment or charger with wet hands to avoid short circuits, failure, or electric shock.
- Do not use the charger if wet.

Battery safety

- VR Headsets are equipped with non-removable internal batteries. Do not attempt to replace the battery, as doing so may cause battery damage, fire, or human injury. The battery can only be replaced by Pico or Pico authorized service providers.
- Do not disassemble or modify the battery, insert foreign objects, or immerse in water or other liquid. Handling the battery as such can cause chemical leakage, overheating, fire, or explosion. If the battery appears to be leaking material, avoid contact with skin or eyes.
- In case of material contact with skin or eyes, immediately rinse with clear water and contact your local poison authority.
- Do not drop, squeeze, or puncture the battery. Avoid subjecting the battery to high temperatures or external pressure, which may result in corruption and overheating of the battery.

EU REGULATORY CONFORMANCE

The SAR limit adopted by Europe is 2.0W/kg averaged over 10 grams of tissue. The highest SAR value for this device type when tested at the Head is 0.289W/kg. Hereby, Qingdao Pico Technology Co., Ltd. declares that this device complies with the essential requirements and other relevant provisions of Directive 2014/53/EU.

"DECLARATION OF CONFORMITY" of "CONFORMITY EUROPEENNE"

DOC Website: www.pico-interactive.com/certifications/DOC_neo3.pdf

VR Headset:

Frequency Range(BT): 2400-2483.5MHz

Max Output Power(BT): 994dBm

Frequency Range(WiFi): 2400-2483.5MHz, 5150-5350MHz Indoor use only, 5470-5725MHz, 5725-5850MHz

Max Output Power(WiFi): 2400-2483.5MHz: 20dBm; 5150-5350MHz, 5470-5725MHz: 23dBm; 5725-5850MHz: 13.98dBm

Controller:

Frequency Range (2.4GHz): 2400-2483.5MHz

Max Output Power: 9.76dBm

Disposal and recycling information

The crossed-out wheeled bin symbol on your product, battery, the literature or packaging reminds you that all electronic products and batteries must be taken to separate waste collection points at the end of their working lives; they must not be disposed of in the normal waste stream with household garbage. It is the responsibility of the user to dispose of the equipment using a designated collection point or service for separate recycling of waste electrical and electronic equipment (WEEE) and batteries according to local laws.

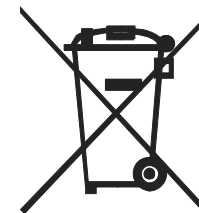

Proper collection and recycling of your equipment helps ensure electrical and electronic equipment (EEE) waste is recycled in a manner that conserves valuable materials and protects human health and the environment, improper handling, accidental breakage, damage, and/or improper recycling at the end of its life may be harmful to health and environment. For more information about where and how to drop off your EEE waste, please contact your local authorities, retailer or household waste disposal service or visit the website www.pico-interactive.com.

This equipment may be operated in



AT	BE	BG	CH	CY	CZ	DE	DK
EE	EL	ES	FI	FR	HR	HU	IE
IS	IT	LI	LT	LU	LV	MT	NL
NO	PL	PT	RO	SE	SI	SK	GB

FCC STATEMENT

This equipment has been tested and found to comply with the limits for a Class B digital device, pursuant to part 15 of the FCC Rules. These limits are designed to provide reasonable protection against harmful interference in a residential installation.

This equipment generates, uses and can radiate radio frequency energy and, if not installed and used in accordance with the instructions, may cause harmful interference to radio communications. However, there is no guarantee that interference will not occur in a particular installation. If this equipment does cause harmful interference to radio or television reception, which can be determined by turning the equipment off and on, the user is encouraged to try to correct the interference by one or more of the following measures:

- Reorient or relocate the receiving antenna.
- Increase the separation between the equipment and receiver.
- Connect the equipment into an outlet on a circuit different from that to which the receiver is connected.
- Consult the dealer or an experienced radio/ TV technician for help.

This device complies with part 15 of the FCC rules. Operation is subject to the following two conditions:

- This device may not cause harmful interference.
- This device must accept any interference received, including interference that may cause undesired operation.

Any changes or modifications not expressly approved by the party responsible for compliance could void the user's authority to operate the equipment.

Note: The manufacturer is not responsible for any radio or TV interference caused by unauthorized modifications to this equipment. Such modifications could void the user's authority to operate the equipment.

FCC RF radiation exposure statement

This equipment complies with FCC RF radiation exposure limits set forth for an uncontrolled environment. This device and its antenna must not be co-located or operating in conjunction with any other antenna or transmitter.

"Supplier's Declaration of Conformity 47 CFR §2.1077 Compliance Information"

SDOC Website: www.pico-interactive.com/certifications/SDOC_neo3.pdf

Product Warranty Terms

Devices can be repaired, free of charge, within 12 months of the purchase date. Please contact Pico's support if you require repair services.

Limited warranty

The limited warranty does not cover:

- Defects or damage resulting from improper usage, maintenance, not included in this manual;
- Storing or shipping items not included with the original product inside the original product packaging;
- Defects or damage resulting from unauthorized disassembly, alteration, or maintenance;
- Damage caused by force majeure such as fire, flood, and lightning,
- The product has exceeded the valid period of the warranty.

CANADIAN COMPLIANCE STATEMENT

This device complies with Industry Canada license-exempt RSSs. Operation is subject to the following two conditions:

1. This device may not cause interference, and
2. This device must accept any interference, including interference that may cause undesired operation of the device.

Caution:

The device for operation in the band 5150–5250 MHz is only for indoor use to reduce the potential for harmful interference to co-channel mobile satellite systems;

The high-power radars are allocated as primary users (i.e. priority users) of the bands 5250–5350 MHz and 5650–5850 MHz and that these radars could cause interference and/or damage to LE-LAN devices.

DFS (Dynamic Frequency Selection) products that operate in the bands 5250–5350 MHz, 5470–5600MHz, and 5650–5725MHz. The exposure standard for wireless transmitter employs a unit of measurement known as the Specific Absorption Rate, or SAR. The SAR limit set by the IC is 1.6 W/kg.

The highest SAR value for the EUT as reported to the IC when tested for use is 1.404W/kg.

DECLARATION DE CONFORMITE DU CANADA

Déclaration de conformité du Canada

Le présent appareil est conforme aux CNR d'Industrie Canada applicables aux appareils radio exempts de licence. L'exploitation est autorisée aux deux conditions suivantes :

1. l'appareil ne doit pas produire de brouillage;
2. l'utilisateur de l'appareil doit accepter tout brouillage radioélectrique subi, même si le brouillage est susceptible d'en compromettre le fonctionnement.

Avertissement:

Le dispositif fonctionnant dans la bande 5150-5250 MHz est réservé uniquement pour une utilisation à l'intérieur afin de réduire les risques de brouillage préjudiciable aux systèmes de satellites mobiles utilisant les mêmes canaux.

En outre, les utilisateurs devraient aussi être avisés que les utilisateurs de radars de haute puissance sont désignés utilisateurs principaux (c.-à-d., qu'ils ont la priorité) pour les bandes 5250-5350 MHz et 5650-5850 MHz et que ces radars pourraient causer du brouillage et/ou des dommages aux dispositifs LAN-EL.

Les produits utilisant la technique d'atténuation DFS (sélection dynamique des fréquences) sur les bandes 5250-5350 MHz, 5470-5600MHz et 5650-5725MHz.
CAN ICES-3 (B)/NMB-3(B)

La norme d'exposition pour l'émetteur sans fil utilise une unité de mesure connue sous le nom de taux d'absorption spécifique, ou SAR. La limite SAR fixée par l'IC est de 1,6 W/kg.

La valeur SAR la plus élevée pour l'EUT signalée à l'IC lorsqu'elle est testée pour l'utilisation à l'oreille est de 1.404W/kg et.

Laws and Regulations

Copyright © 2015–2021 Qingdao Pico Technology Co., Ltd. All Rights Reserved.

This information is for reference only and does not constitute any form of commitment. Products (including but not limited to color, size, and screen display.) shall be subject to physical objects.

User Software License Agreement

Before using the product, please read the software license agreement carefully. When starting to use the product, you agree to be bound by the license agreement.

If you do not agree to the terms of this agreement, do not use the product and software, and return the product to its original place for a refund.

For more details about the agreement, please visit:

https://www.pico-interactive.com/terms/user_terms.html

Privacy Protection

To learn how we protect your personal information, please visit:

<https://www.pico-interactive.com/terms/privacy.html>

Read our privacy policy.

Product Name: VR All-In-One Headset

Headset Model: A7H10

Controller Model: C1710

For more information about Pico's products, policy, and authorized servers, please visit Pico's official website: **www.pico-interactive.com**

Company Name: Qingdao Pico Technology Co., Ltd.

Company Address: 4th Floor, No.3 Building, No.393 Songling Road, Qingdao, Shandong, P.R.China.

Tel: +86 400-6087-666

Service Mail: service@picovr.com

Importer Information:

Company Name(EU): Pico Interactive Europe, S.L.

Company Address(EU): CarrerdelBruc149,DepotLab,Barcelona,08037–Spain

Company Name(NA): Pico Interactive Inc.

Company Address(NA): 222 Columbus Ave, Unit 420, San Francisco, CA94133



Official account: @pico-interactive